

ELECTRICITY & MAGNETISM

A PART OF

B.Sc. Physics (Hons.) Old syllabus: Paper-III & Paper VI

B.Sc. Physics (Hons.) Semester: II (CBCS); Course: CC-III



DR. SHYAMSUNDAR GHOSH

Assistant Professor,

Department of Physics,

Bejoy Narayan Mahavidyalaya,

Hooghly-712147

ELECTROMAGNETIC INDUCTION

1. Magnetic Flux
2. Faraday's Experiments
3. Faraday's Laws of Electromagnetic Induction
4. Lenz's Law and Law of Conservation of Energy
5. Expression for Induced emf based on both laws
6. Methods of producing induced emf
 - a) By changing Magnetic Field
 - b) By changing the Area of the Coil (Motional emf)
 - c) By changing the Relative Orientation of the coil with the Magnetic Field
7. Eddy Currents
8. Self Induction and Self Inductance
9. Mutual Induction and Mutual Inductance
10. Additional Information

Magnetic Flux (Φ):

Magnetic Flux through any surface is the number of magnetic lines of force passing normally through that surface.

It can also be defined as the product of the area of the surface and the component of the magnetic field normal to that surface.

$$d\Phi = \vec{B} \cdot d\vec{s} = B ds \hat{n}$$

$$d\Phi = B \cdot ds \cos \theta$$

$$\Phi = \vec{B} \cdot \vec{A} = B \cdot A \hat{n}$$

$$\Phi = B \cdot A \cos \theta$$

Direction of $d\vec{s}$ is along the normal to the surface and \hat{n} is unit normal vector.

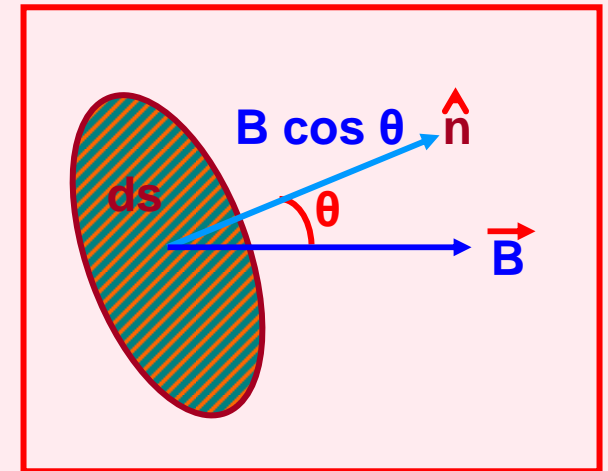

Positive Flux:

Magnetic Flux is positive for $0^\circ \leq \theta < 90^\circ$ & $270^\circ < \theta \leq 360^\circ$

Zero Flux:

Magnetic Flux is zero for $\theta = 90^\circ$ & $\theta = 270^\circ$

Negative Flux:

Magnetic Flux is negative for $90^\circ < \theta < 270^\circ$

Flux is maximum when $\theta = 0^\circ$ and is $\Phi = B \cdot A$

$$\Phi = B \cdot A \cos \theta$$

Magnetic Flux across a coil can be changed by changing :

- 1) the strength of the magnetic field B**
- 2) the area of cross section of the coil A**
- 3) the orientation of the coil with magnetic field θ or**
- 4) any of the combination of the above**

- * Magnetic flux is a scalar quantity.**
- * SI unit of magnetic flux is weber or tesla-metre² or (wb or Tm²).**
- * cgs unit of magnetic flux is maxwell.**
- * 1 maxwell = 10⁻⁸ weber**
- * Magnetic flux (associated normally) per unit area is called Magnetic Flux Density or Strength of Magnetic Field or Magnetic Induction (B).**

Faraday's Experiment - 1:

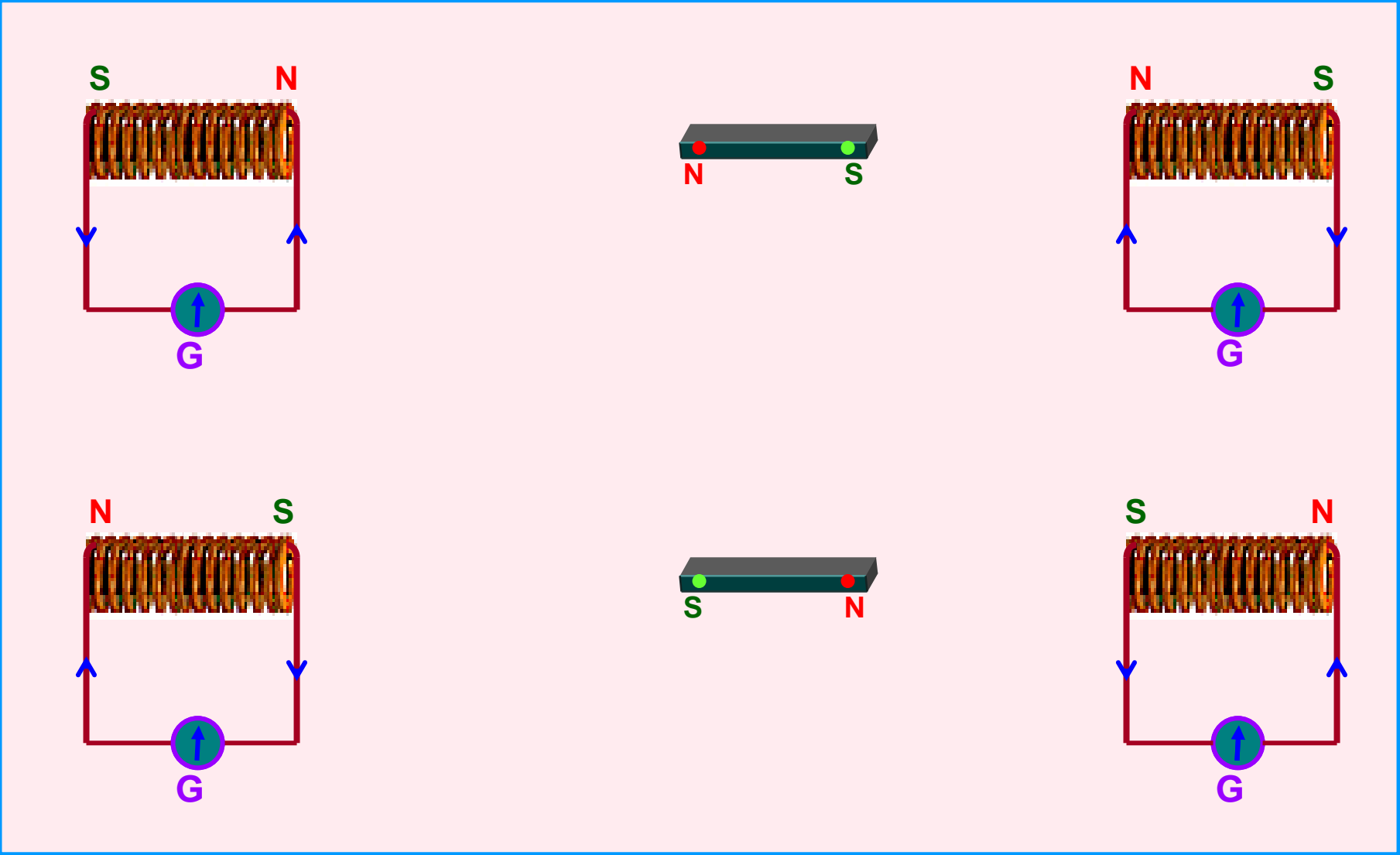

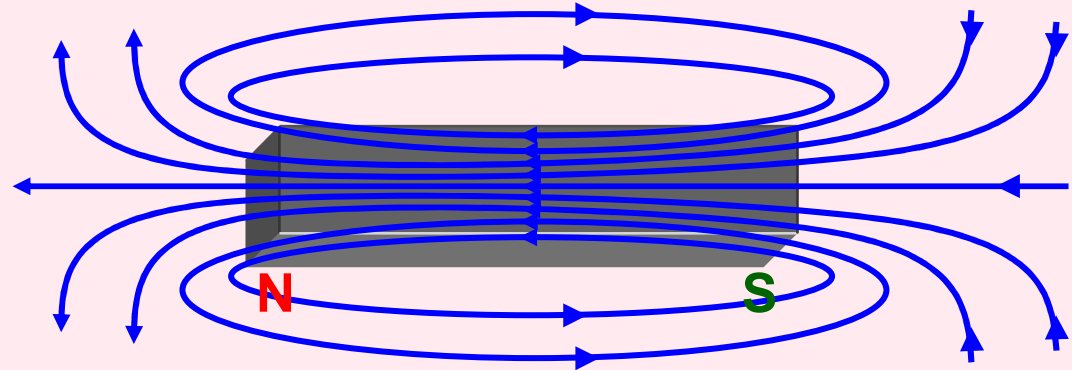
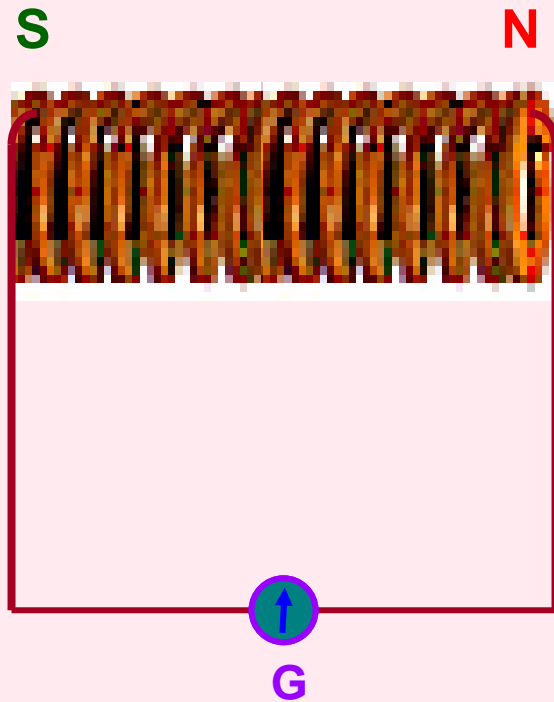

Magnetic flux linked with the coil changes relative to the positions of the coil and the magnet due to the magnetic lines of force cutting at different angles at the same cross sectional area of the coil.

Observe:

- i) the relative motion between the coil and the magnet
- ii) the induced polarities of magnetism in the coil
- iii) the direction of current through the galvanometer and hence the deflection in the galvanometer
- iv) that the induced current (e.m.f) is available only as long as there is relative motion between the coil and the magnet

Note:

- i) coil can be moved by fixing the magnet
- ii) both the coil and magnet can be moved (towards each other or away from each other) i.e. there must be a relative velocity between them
- iii) magnetic flux linked with the coil changes relative to the positions of the coil and the magnet
- iv) current and hence the deflection is large if the relative velocity between the coil and the magnet and hence the rate of change of flux across the coil is more

Faraday's Experiment - 2:

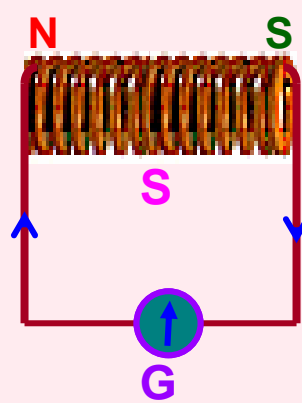
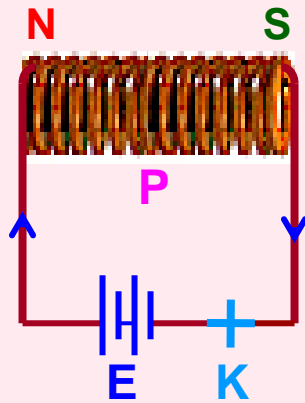
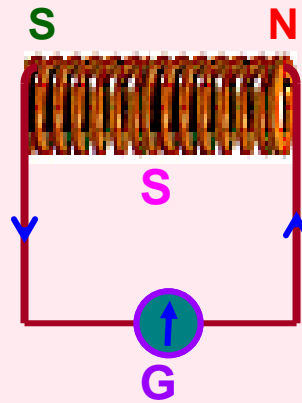
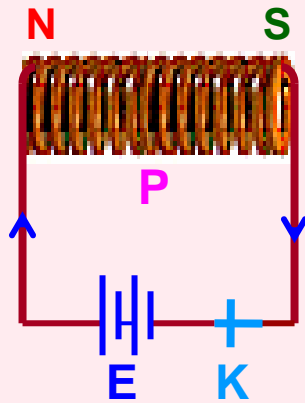

When the primary circuit is closed current grows from zero to maximum value.

During this period changing, current induces changing magnetic flux across the primary coil.

This changing magnetic flux is linked across the secondary coil and induces e.m.f (current) in the secondary coil.

Induced e.m.f (current) and hence deflection in galvanometer lasts only as long as the current in the primary coil and hence the magnetic flux in the secondary coil change.

When the primary circuit is open current decreases from maximum value to zero.

During this period changing current induces changing magnetic flux across the primary coil.

This changing magnetic flux is linked across the secondary coil and induces current (e.m.f) in the secondary coil.

However, note that the direction of current in the secondary coil is reversed and hence the deflection in the galvanometer is opposite to the previous case.

Faraday's Laws of Electromagnetic Induction:

I Law:

Whenever there is a change in the magnetic flux linked with a circuit, an emf and hence a current is induced in the circuit. However, it lasts only so long as the magnetic flux is changing.

II Law:

The magnitude of the induced emf is directly proportional to the rate of change of magnetic flux linked with a circuit.

$$E \propto d\Phi / dt \implies E = k d\Phi / dt \implies E = d\Phi / dt \implies E = (\Phi_2 - \Phi_1) / t$$

(where k is a constant and units are chosen such that k = 1)

Lenz's Law:

The direction of the induced emf or induced current is such that it opposes the change that is producing it.

i.e. If the current is induced due to motion of the magnet, then the induced current in the coil sets itself to stop the motion of the magnet.

If the current is induced due to change in current in the primary coil, then induced current is such that it tends to stop the change.

Lenz's Law and Law of Conservation of Energy:

According to Lenz's law, the induced emf opposes the change that produces it. It is this opposition against which we perform mechanical work in causing the change in magnetic flux. Therefore, mechanical energy is converted into electrical energy. Thus, Lenz's law is in accordance with the law of conservation of energy.

If, however, the reverse would happen (i.e. the induced emf does not oppose or aids the change), then a little change in magnetic flux would produce an induced current which would help the change of flux further thereby producing more current. The increased emf would then cause further change of flux and it would further increase the current and so on. This would create energy out of nothing which would violate the law of conservation of energy.

Expression for Induced emf based on both the laws:

$$E = - d\Phi / dt$$

$$E = - (\Phi_2 - \Phi_1) / t$$

And for 'N' no. of turns of the coil,

$$E = - N d\Phi / dt$$

$$E = - N (\Phi_2 - \Phi_1) / t$$

Expression for Induced current:

$$I = - d\Phi / (R dt)$$

Expression for Charge:

$$dq / dt = - d\Phi / (R dt)$$

$$dq = - d\Phi / R$$

Note:

Induced emf does not depend on resistance of the circuit where as the induced current and induced charge depend on resistance.

Methods of producing Induced emf:

1. By changing Magnetic Field B:

Magnetic flux Φ can be changed by changing the magnetic field B and hence emf can be induced in the circuit (as done in Faraday's Experiments).

2. By changing the area of the coil A available in Magnetic Field:

Magnetic flux Φ can be changed by changing the area of the loop A which is acted upon by the magnetic field B and hence emf can be induced in the circuit.

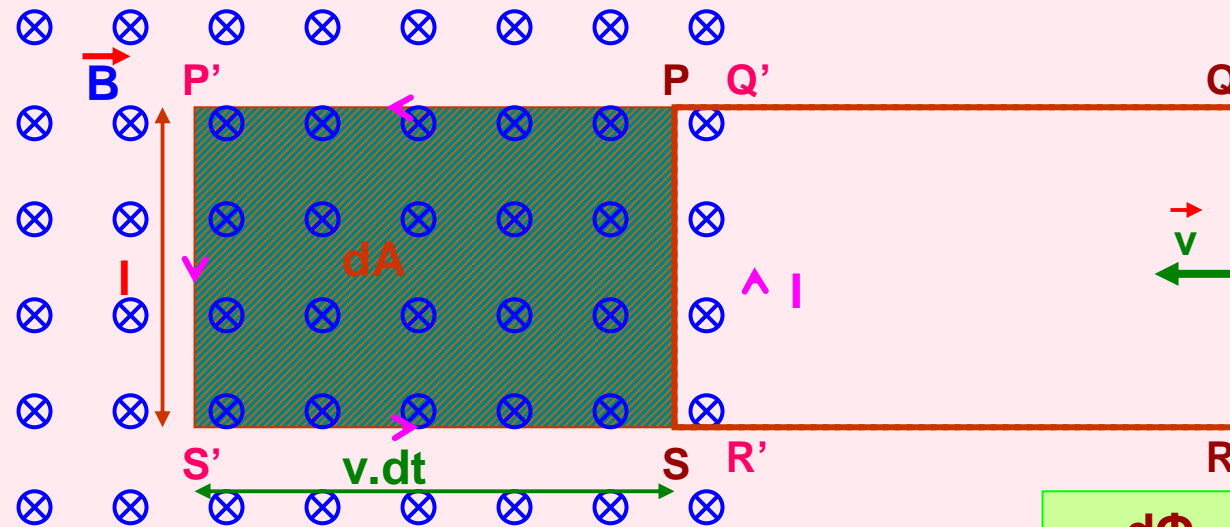

The loop PQRS is slid into uniform and perpendicular magnetic field. The change (increase) in area of the coil under the influence of the field is dA in time dt . This causes an increase in magnetic flux $d\Phi$.

$$\begin{aligned}d\Phi &= B \cdot dA \\ &= B \cdot l \cdot v \cdot dt \\ E &= - d\Phi / dt \\ \therefore E &= - Blv\end{aligned}$$

The induced emf is due to motion of the loop and so it is called '**motional emf**'.

If the loop is pulled out of the magnetic field, then $E = Blv$

The direction of induced current is anticlockwise in the loop. i.e. $P'S'R'Q'P'$ by Fleming's Right Hand Rule or Lenz's Rule.

According to Lenz's Rule, the direction of induced current is such that it opposes the cause of changing magnetic flux.

Here, the cause of changing magnetic flux is due to motion of the loop and increase in area of the coil in the uniform magnetic field.

Therefore, this motion of the loop is to be opposed. So, the current is set such that by Fleming's Left Hand Rule, the conductor arm PS experiences force to the right whereas the loop is trying to move to the left.

Against this force, mechanical work is done which is converted into electrical energy (induced current).

NOTE: If the loop is completely inside the boundary of magnetic field, then there will not be any change in magnetic flux and so there will not be induced current in the loop.

Fleming's Right Hand Rule:

If the central finger, fore finger and thumb of right hand are stretched mutually perpendicular to each other and the fore finger points to magnetic field, thumb points in the direction of motion (force), then central finger points to the direction of induced current in the conductor.

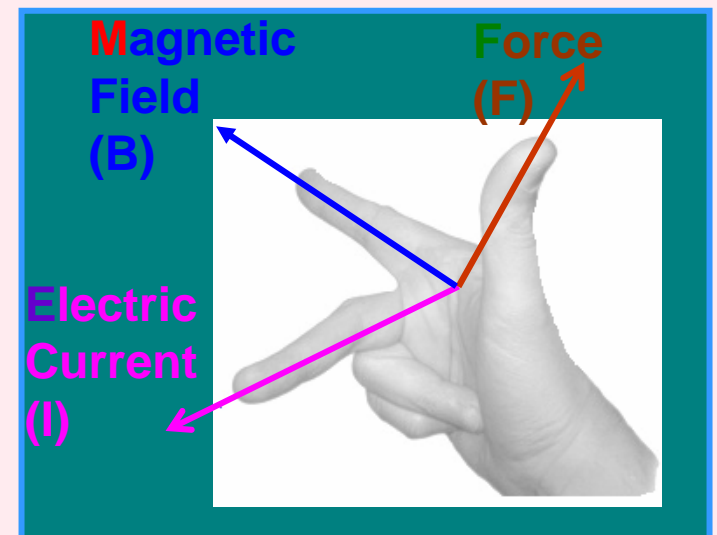

3. By changing the orientation of the coil (θ) in Magnetic Field:

Magnetic flux Φ can be changed by changing the relative orientation of the loop (θ) with the magnetic field B and hence emf can be induced in the circuit.

$$\Phi = N B A \cos \theta$$

At time t , with angular velocity ω ,

$\theta = \omega t$ (at $t = 0$, loop is assumed to be perpendicular to the magnetic field and $\theta = 0^\circ$)

$$\therefore \Phi = N B A \cos \omega t$$

Differentiating w.r.t. t ,

$$d\Phi / dt = - N B A \omega \sin \omega t$$

$$E = - d\Phi / dt$$

$$E = N B A \omega \sin \omega t$$

$E = E_0 \sin \omega t$ (where $E_0 = N B A \omega$ is the maximum emf)

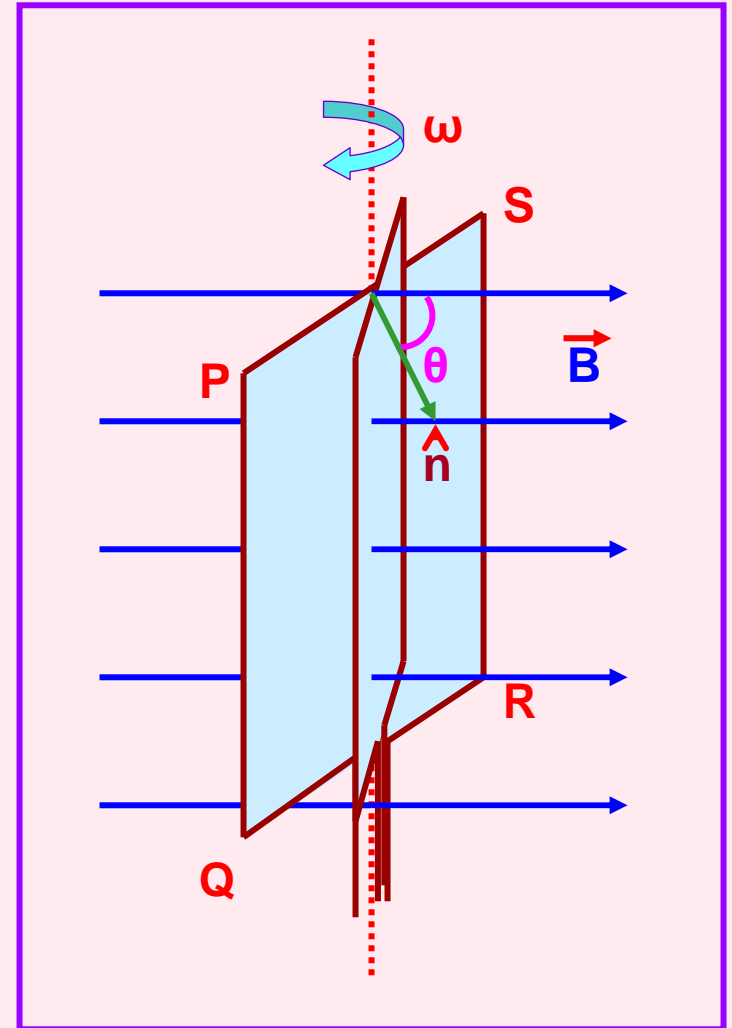

The emf changes continuously in magnitude and periodically in direction w.r.t. time giving rise to alternating emf.

If initial position of the coil is taken as 0° , i.e. normal to the coil is at 90° with the magnetic field, then θ becomes $\theta + \pi/2$ or $\omega t + \pi/2$

$$\therefore E = E_0 \cos \omega t$$

So, alternating emf and consequently alternating current can be expressed in **sin** or **cos** function.

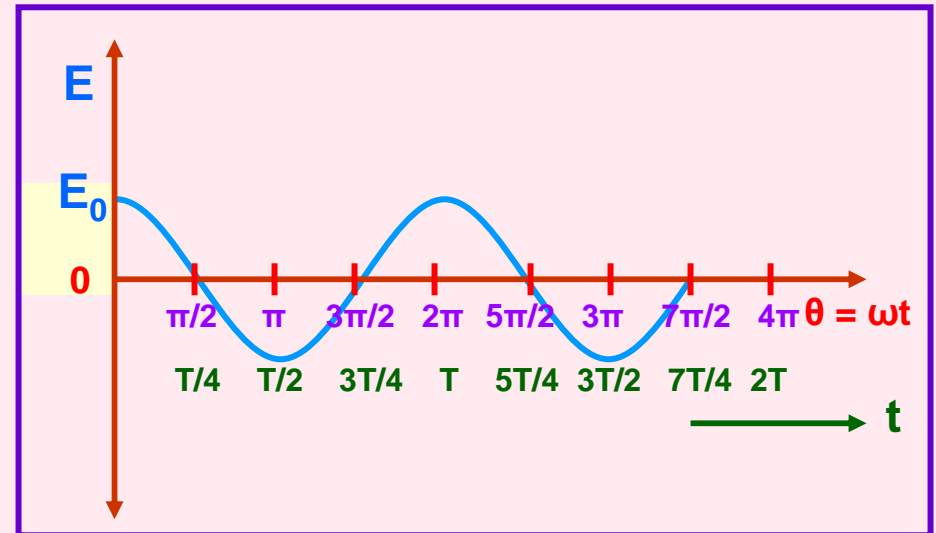
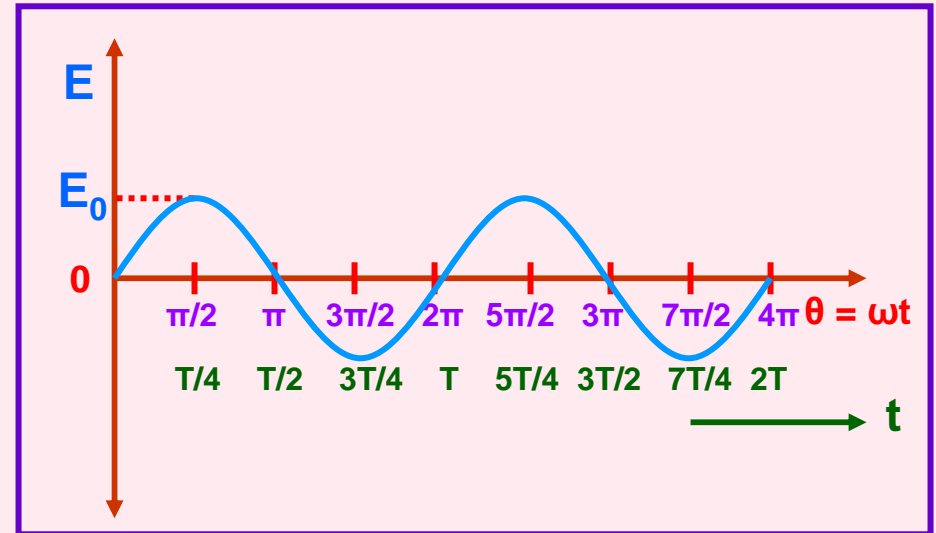

This method of inducing emf is the basic principle of generators.

Eddy Currents or Foucault Currents:

The induced circulating (looping) currents produced in a solid metal due to change in magnetic field (magnetic flux) in the metal are called eddy currents.

Applications of Eddy Currents:

1. In induction furnace eddy currents are used for melting iron ore, etc.
2. In speedometer eddy currents are used to measure the instantaneous speed of the vehicle.
3. In dead beat galvanometer eddy currents are used to stop the damping of the coil in a shorter interval.
4. In electric brakes of the train eddy currents are produced to stop the rotation of the axle of the wheel.
5. In energy meters (watt – meter) eddy currents are used to measure the consumption of electric energy.
6. In diathermy eddy currents are used for localised heating of tissues in human bodies.

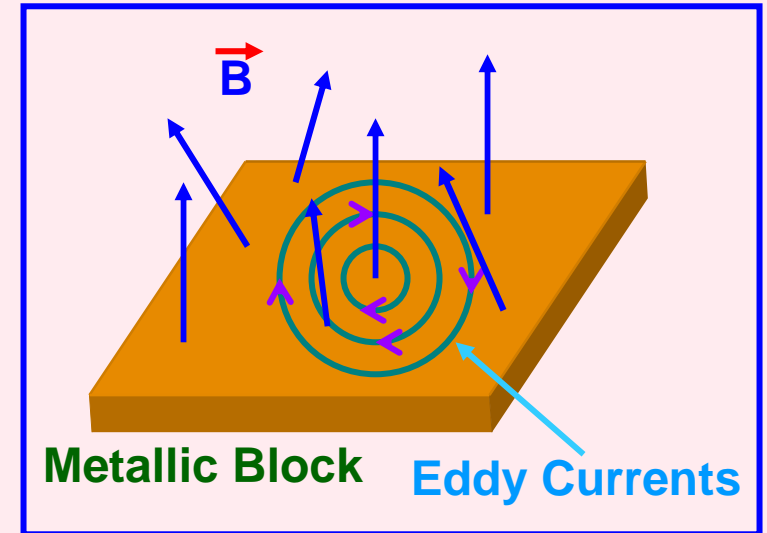

Self Induction:

Self Induction is the phenomenon of inducing emf in the self coil due to change in current and hence the change in magnetic flux in the coil.

The induced emf opposes the growth or decay of current in the coil and hence delays the current to acquire the maximum value.

Self induction is also called inertia of electricity as it opposes the growth or decay of current.

Self Inductance:

$\Phi \propto I$ or $\Phi = LI$ (where L is the constant of proportionality and is known as Self Inductance or co-efficient of self induction)

If $I = 1$, then $L = \Phi$

Thus, self inductance is defined as the magnetic flux linked with a coil when unit current flows through it.

Also, $E = - d\Phi / dt$ or $E = - L (dI / dt)$

If $dI / dt = 1$, then $L = E$

Thus, self inductance is defined as the induced emf set up in the coil through which the rate of change of current is unity.

SI unit of self inductance is henry (H).

Self inductance is said to be 1 henry when 1 A current in a coil links magnetic flux of 1 weber.

or

Self inductance is said to be 1 henry when unit rate of change of current (1 A / s) induces emf of 1 volt in the coil.

Self inductance of a solenoid:

Magnetic Field due to the solenoid is

$$B = \mu_0 n l$$

Magnetic Flux linked across one turn of the coil is

$$\Phi \text{ per turn} = B A = \mu_0 n l A = \mu_0 N I A / l$$

Magnetic Flux linked across N turns of the coil is

$$\Phi = \mu_0 N^2 I A / l$$

But, $\Phi = L I$

So, $L = \mu_0 N^2 A / l = \mu_0 n^2 A l$

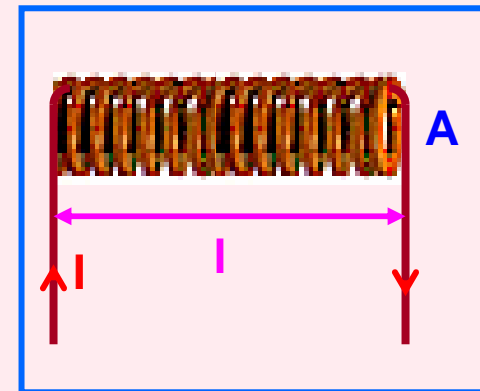

Energy in Inductor:

Small work done dW in establishing a current I in the coil in time dt is $dW = - E I dt$

$$dW = L I dl \quad (\text{since } E = -L(dl / dt))$$

$$W = \int_0^{I_0} L I dl = \frac{1}{2} L I_0^2$$

Mutual Induction:

Mutual Induction is the phenomenon of inducing emf in the secondary coil due to change in current in the primary coil and hence the change in magnetic flux in the secondary coil.

Mutual Inductance:

$\Phi_{21} \propto I_1$ or $\Phi_{21} = MI_1$ (where M is the constant of proportionality and is known as Mutual Inductance or co-efficient of mutual induction)

If $I_1 = 1$, then $M = \Phi$

Thus, mutual inductance is defined as the magnetic flux linked with the secondary coil when unit current flows through the primary coil.

Also, $E_2 = -d\Phi_{21} / dt$ or $E_2 = -M (dI_1 / dt)$

If $dI_1 / dt = 1$, then $M = E$

Thus, mutual inductance is defined as the induced emf set up in the secondary coil when the rate of change of current in primary coil is unity.

SI unit of mutual inductance is henry (H).

Mutual inductance is said to be 1 henry when 1 A current in the primary coil links magnetic flux of 1 weber across the secondary coil. or

Mutual inductance is said to be 1 henry when unit rate of change of current (1 A / s) in primary coil induces emf of 1 volt in the secondary coil.

Mutual inductance of two long co-axial solenoids:

Magnetic Field due to primary solenoid is

$$B_1 = \mu_0 n_1 I_1$$

Magnetic Flux linked across one turn of the secondary solenoid is

$$\Phi_{21} \text{ per turn} = B_1 A = \mu_0 n_1 I_1 A = \mu_0 N_1 I_1 A / l$$

Magnetic Flux linked across N turns of the secondary solenoid is

$$\Phi_{21} = \mu_0 N_1 N_2 I_1 A / l$$

But, $\Phi_{21} = M_{21} I_1$

$$M_{21} = \mu_0 N_1 N_2 A / l = \mu_0 n_1 n_2 A l$$

Similarly $M_{12} = \mu_0 N_1 N_2 A / l = \mu_0 n_1 n_2 A l$

- ∴ For two long co-axial solenoids of same length and cross-sectional area, the mutual inductance is same and leads to principle of reciprocity.

$$M = M_{12} = M_{21}$$

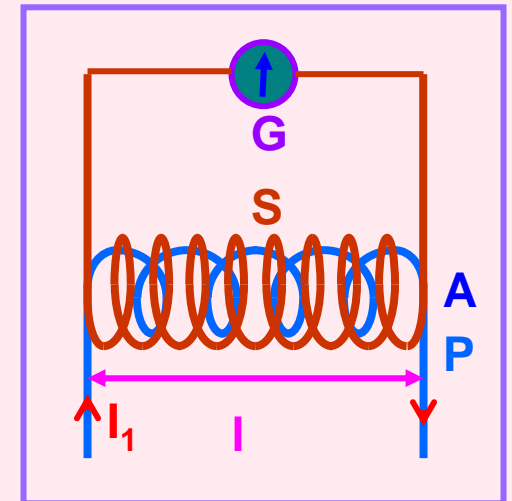

Additional Information:

- 1) If the two solenoids are wound on a magnetic core of relative permeability μ_r , then

$$M = \mu_0 \mu_r N_1 N_2 A / l$$

- 2) If the solenoids S_1 and S_2 have no. of turns N_1 and N_2 of different radii r_1 and r_2 ($r_1 < r_2$), then

$$M = \mu_0 \mu_r N_1 N_2 (\pi r_1^2) / l$$

- 3) Mutual inductance depends also on the relative placement of the solenoids.

- 4) Co-efficient of Coupling (K) between two coils having self-inductance L_1 and L_2 and mutual inductance M is

$$K = M / (\sqrt{L_1 L_2}) \quad \text{Generally, } K < 1$$

- 5) If L_1 and L_2 are in series, then $L = L_1 + L_2$

- 6) If L_1 and L_2 are in parallel, then $(1/L) = (1/L_1) + (1/L_2)$

ALTERNATING CURRENTS

1. Alternating EMF and Current
2. Average or Mean Value of Alternating EMF and Current
3. Root Mean Square Value of Alternating EMF and Current
4. A C Circuit with Resistor
5. A C Circuit with Inductor
6. A C Circuit with Capacitor
7. A C Circuit with Series LCR – Resonance and Q-Factor
8. Graphical Relation between Frequency vs X_L , X_C
9. Power in LCR A C Circuit
10. Watt-less Current
11. L C Oscillations
12. Transformer
13. A.C. Generator

Alternating emf:

Alternating emf is that emf which continuously changes in magnitude and periodically reverses its direction.

Alternating Current:

Alternating current is that current which continuously changes in magnitude and periodically reverses its direction.

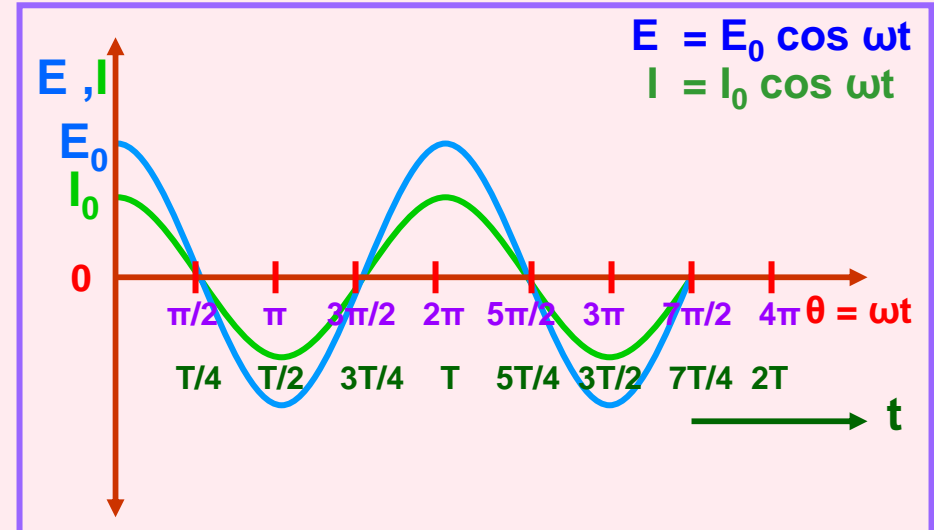
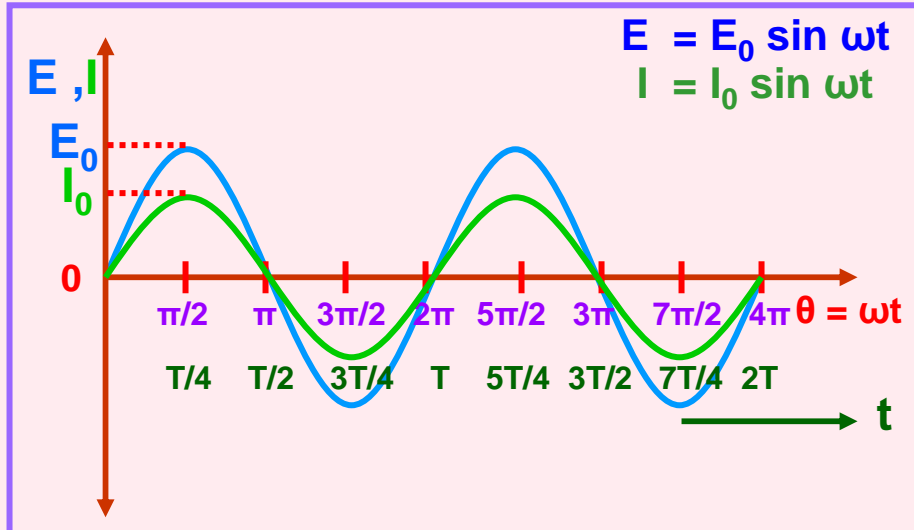

E, I – Instantaneous value of emf and current

E_0, I_0 – Peak or maximum value or amplitude of emf and current

ω – Angular frequency t – Instantaneous time

ωt – Phase

Symbol of
AC Source



Average or Mean Value of Alternating Current:

Average or Mean value of alternating current over half cycle is that steady current which will send the same amount of charge in a circuit in the time of half cycle as is sent by the given alternating current in the same circuit in the same time.

$$dq = I dt = I_0 \sin \omega t dt$$

$$q = \int_0^{T/2} I_0 \sin \omega t dt$$

$$q = 2 I_0 / \omega = 2 I_0 T / 2\pi = I_0 T / \pi$$

Mean Value of AC, $I_m = I_{av} = q / (T/2)$

$$I_m = I_{av} = 2 I_0 / \pi = 0.637 I_0 = 63.7 \% I_0$$

Average or Mean Value of Alternating emf:

$$E_m = E_{av} = 2 E_0 / \pi = 0.637 E_0 = 63.7 \% E_0$$

Note: Average or Mean value of alternating current or emf is zero over a cycle as the + ve and – ve values get cancelled.

Root Mean Square or Virtual or Effective Value of Alternating Current:

Root Mean Square (rms) value of alternating current is that steady current which would produce the same heat in a given resistance in a given time as is produced by the given alternating current in the same resistance in the same time.

$$dH = I^2 R dt = I_0^2 R \sin^2 \omega t dt$$

$$H = \int_0^T I_0^2 R \sin^2 \omega t dt$$

$$H = I_0^2 RT / 2 \quad (\text{After integration, } \omega \text{ is replaced with } 2\pi / T)$$

If I_v be the virtual value of AC, then

$$H = I_v^2 RT \quad \therefore \quad I_v = I_{\text{rms}} = I_{\text{eff}} = I_0 / \sqrt{2} = 0.707 I_0 = 70.7 \% I_0$$

Root Mean Square or Virtual or Effective Value of Alternating emf:

$$E_v = E_{\text{rms}} = E_{\text{eff}} = E_0 / \sqrt{2} = 0.707 E_0 = 70.7 \% E_0$$

Note:

1. Root Mean Square value of alternating current or emf can be calculated over any period of the cycle since it is based on the heat energy produced.
2. Do not use the above formulae if the time interval under the consideration is less than one period.

Relative Values Peak, Virtual and Mean Values of Alternating emf:

$$E_m = E_{av} = 0.637 E_0$$

$$E_v = E_{rms} = E_{eff} = 0.707 E_0$$

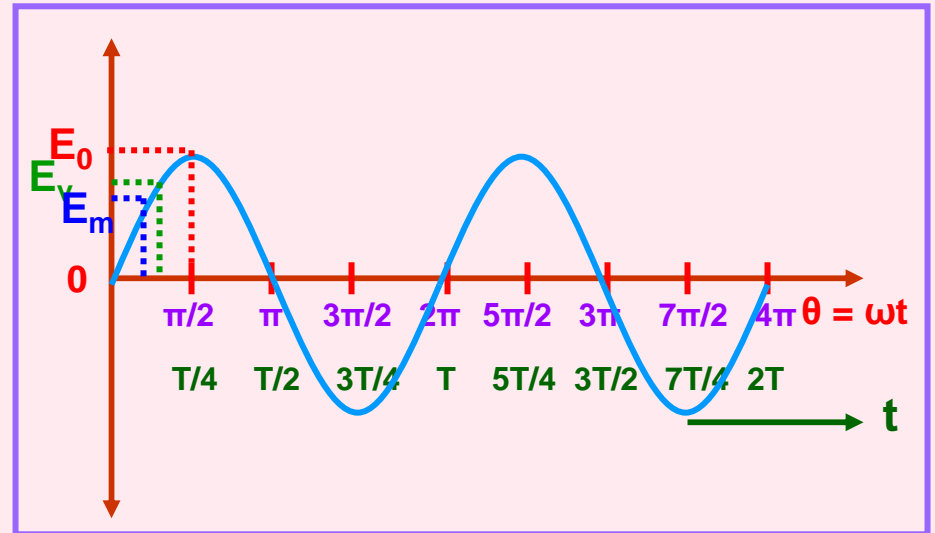

Tips:

1. The given values of alternating emf and current are virtual values unless otherwise specified.
i.e. 230 V AC means $E_v = E_{rms} = E_{eff} = 230 V$
2. AC Ammeter and AC Voltmeter read the rms values of alternating current and voltage respectively.
They are called as 'hot wire meters'.
3. The scale of DC meters is linearly graduated where as the scale of AC meters is not evenly graduated because $H \propto I^2$

AC Circuit with a Pure Resistor:

$$E = E_0 \sin \omega t$$

$$I = E / R$$

$$= (E_0 / R) \sin \omega t$$

$$I = I_0 \sin \omega t \quad (\text{where } I_0 = E_0 / R \quad \text{and} \quad R = E_0 / I_0)$$

Emf and current are in same phase.

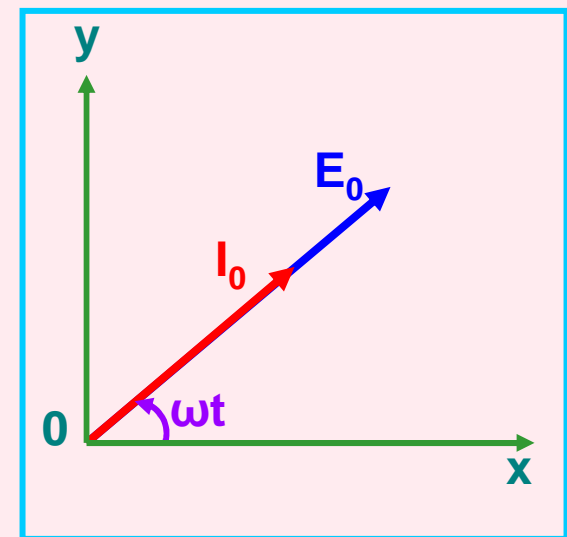
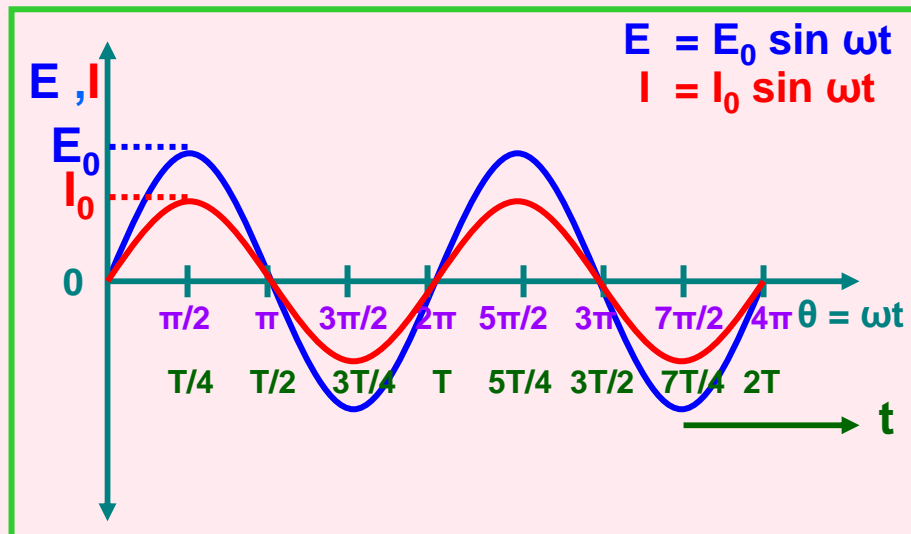
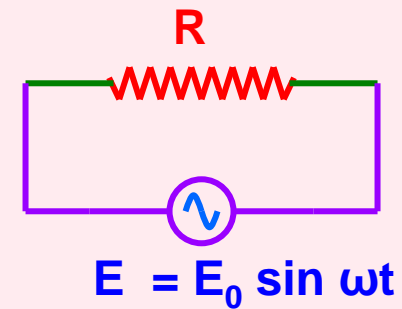

AC Circuit with a Pure Inductor:

$$E = E_0 \sin \omega t$$

Induced emf in the inductor is $-L (di / dt)$

In order to maintain the flow of current, the applied emf must be equal and opposite to the induced emf.

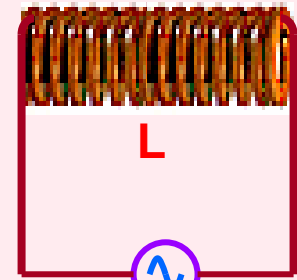

$$E = E_0 \sin \omega t$$

$$\begin{aligned} \therefore E &= L (di / dt) \\ E_0 \sin \omega t &= L (di / dt) \\ di &= (E_0 / L) \sin \omega t dt \end{aligned}$$



$$\begin{aligned} I &= \int (E_0 / L) \sin \omega t dt \\ I &= (E_0 / \omega L) (-\cos \omega t) \\ I &= I_0 \sin (\omega t - \pi / 2) \end{aligned}$$

(where $I_0 = E_0 / \omega L$ and $X_L = \omega L = E_0 / I_0$) Current lags behind emf by $\pi/2$ rad.
 X_L is Inductive Reactance. Its SI unit is ohm.

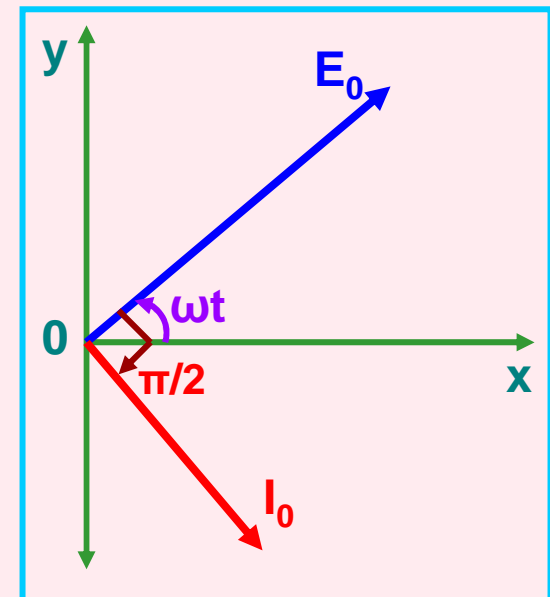
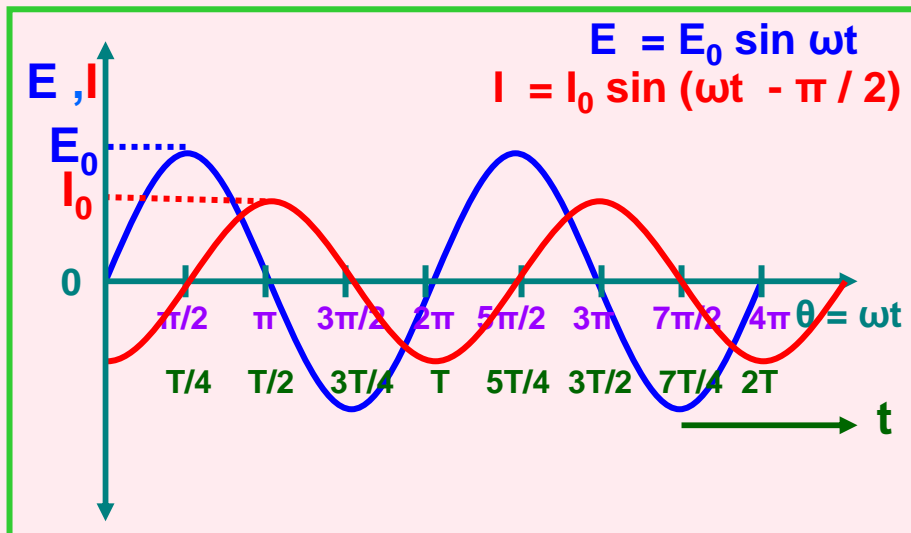

AC Circuit with a Capacitor:

$$E = E_0 \sin \omega t$$

$$q = CE = CE_0 \sin \omega t$$

$$I = dq / dt$$

$$= (d / dt) [CE_0 \sin \omega t]$$

$$I = [E_0 / (1 / \omega C)] (\cos \omega t)$$

$$I = I_0 \sin (\omega t + \pi / 2)$$

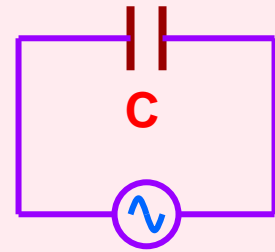

$$E = E_0 \sin \omega t$$

(where $I_0 = E_0 / (1 / \omega C)$ and

$$X_C = 1 / \omega C = E_0 / I_0$$

X_C is Capacitive Reactance.

Its SI unit is ohm.

Current leads the emf by $\pi/2$ radians.

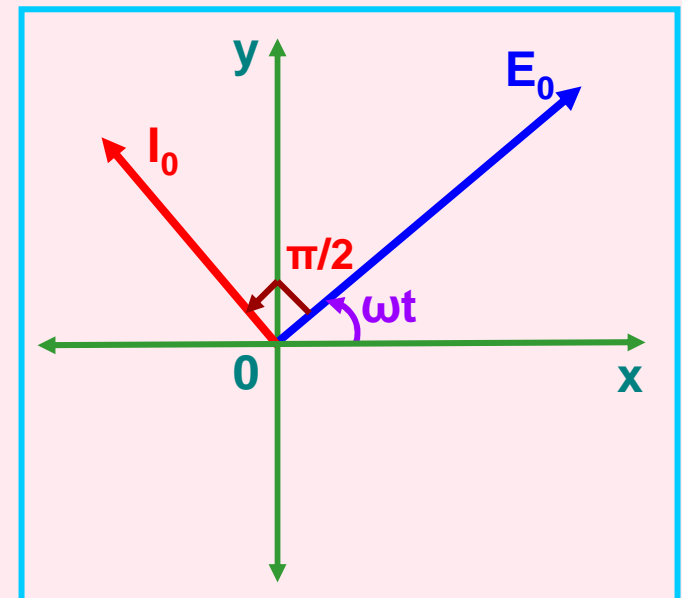
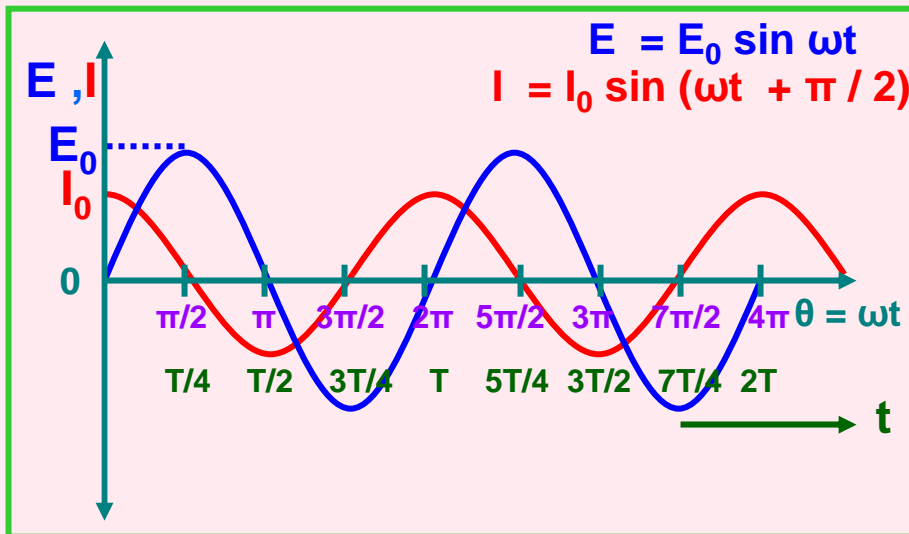

Variation of X_L with Frequency:

$$I_0 = E_0 / \omega L \quad \text{and} \quad X_L = \omega L$$

X_L is Inductive Reactance and $\omega = 2\pi f$

$$X_L = 2\pi f L \quad \text{i.e.} \quad X_L \propto f$$

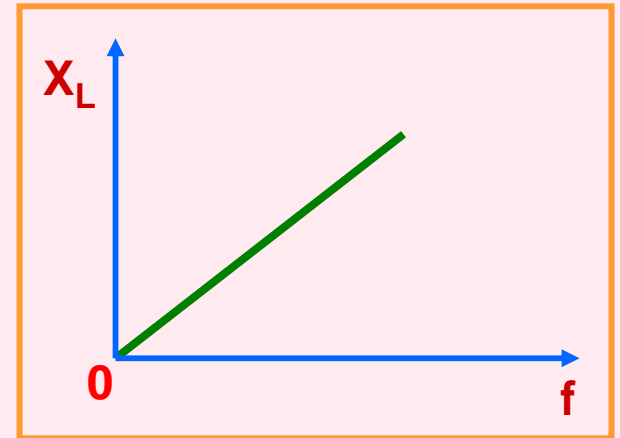

Variation of X_C with Frequency:

$$I_0 = E_0 / (1/\omega C) \quad \text{and} \quad X_C = 1 / \omega C$$

X_C is Inductive Reactance and $\omega = 2\pi f$

$$X_C = 1 / 2\pi f C \quad \text{i.e.} \quad X_C \propto 1 / f$$

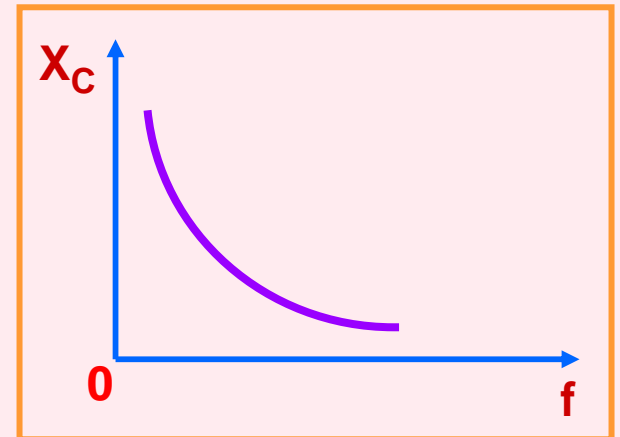

TIPS:

- 1) Inductance (L) can not decrease Direct Current. It can only decrease Alternating Current.
- 2) Capacitance (C) allows AC to flow through it but blocks DC.

AC Circuit with L, C, R in Series Combination:

The applied emf appears as Voltage drops V_R , V_L and V_C across R, L and C respectively.

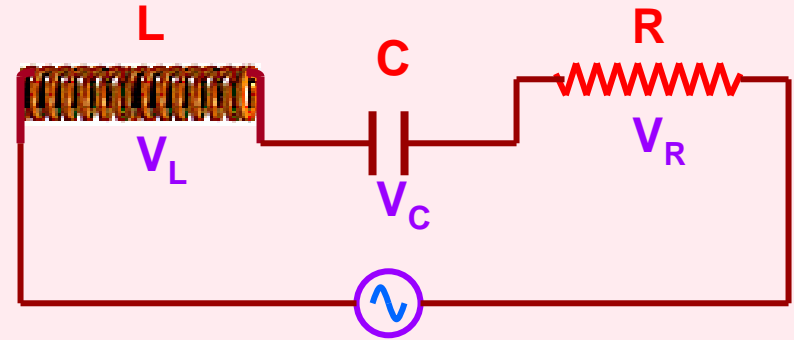

$$E = E_0 \sin \omega t$$

- 1) In R, current and voltage are in phase.
- 2) In L, current lags behind voltage by $\pi/2$
- 3) In C, current leads the voltage by $\pi/2$

$$E = \sqrt{V_R^2 + (V_L - V_C)^2}$$

$$I = \frac{E}{\sqrt{R^2 + (X_L - X_C)^2}}$$

$$Z = \sqrt{R^2 + (X_L - X_C)^2}$$

$$Z = \sqrt{R^2 + (\omega L - 1/\omega C)^2}$$

$$\tan \Phi = \frac{X_L - X_C}{R} \quad \text{or} \quad \tan \Phi = \frac{\omega L - 1/\omega C}{R}$$

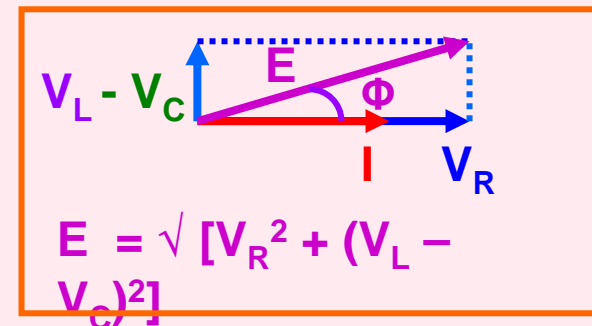
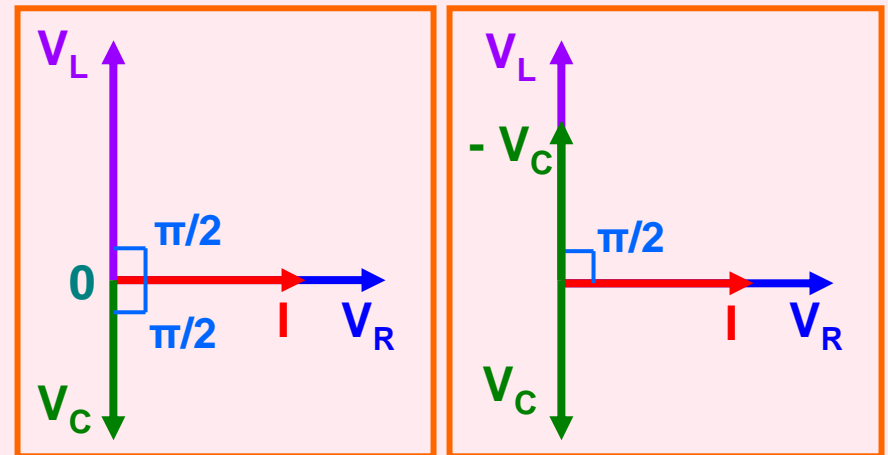

$$\tan \Phi = \frac{X_L - X_C}{R}$$

or

$$\tan \Phi = \frac{\omega L - 1/\omega C}{R}$$

Special Cases:

Case I: When $X_L > X_C$ i.e. $\omega L > 1/\omega C$,

$$\tan \Phi = +ve \text{ or } \Phi \text{ is } +ve$$

The current lags behind the emf by phase angle Φ and the LCR circuit is inductance - dominated circuit.

Case II: When $X_L < X_C$ i.e. $\omega L < 1/\omega C$,

$$\tan \Phi = -ve \text{ or } \Phi \text{ is } -ve$$

The current leads the emf by phase angle Φ and the LCR circuit is capacitance - dominated circuit.

Case III: When $X_L = X_C$ i.e. $\omega L = 1/\omega C$,

$$\tan \Phi = 0 \text{ or } \Phi \text{ is } 0^\circ$$

The current and the emf are in same phase. The impedance does not depend on the frequency of the applied emf. LCR circuit behaves like a purely resistive circuit.

Resonance in AC Circuit with L, C, R:

When $X_L = X_C$ i.e. $\omega L = 1/\omega C$, $\tan \Phi = 0$ or Φ is 0° and

$Z = \sqrt{[R^2 + (\omega L - 1/\omega C)^2]}$ becomes $Z_{\min} = R$ and $I_{0\max} = E / R$

i.e. The impedance offered by the circuit is minimum and the current is maximum. This condition is called resonant condition of LCR circuit and the frequency is called resonant frequency.

At resonant angular frequency ω_r ,

$\omega_r L = 1/\omega_r C$ or $\omega_r = 1 / \sqrt{LC}$ or $f_r = 1 / (2\pi \sqrt{LC})$

Resonant Curve & Q - Factor:

Band width = $2 \Delta \omega$

Quality factor (Q – factor) is defined as the ratio of resonant frequency to band width.

$$Q = \omega_r / 2 \Delta \omega$$

It can also be defined as the ratio of potential drop across either the inductance or the capacitance to the potential drop across the resistance.

$$Q = V_L / V_R \quad \text{or} \quad Q = V_C / V_R$$

$$\text{or} \quad Q = \omega_r L / R \quad \text{or} \quad Q = 1 / \omega_r CR$$

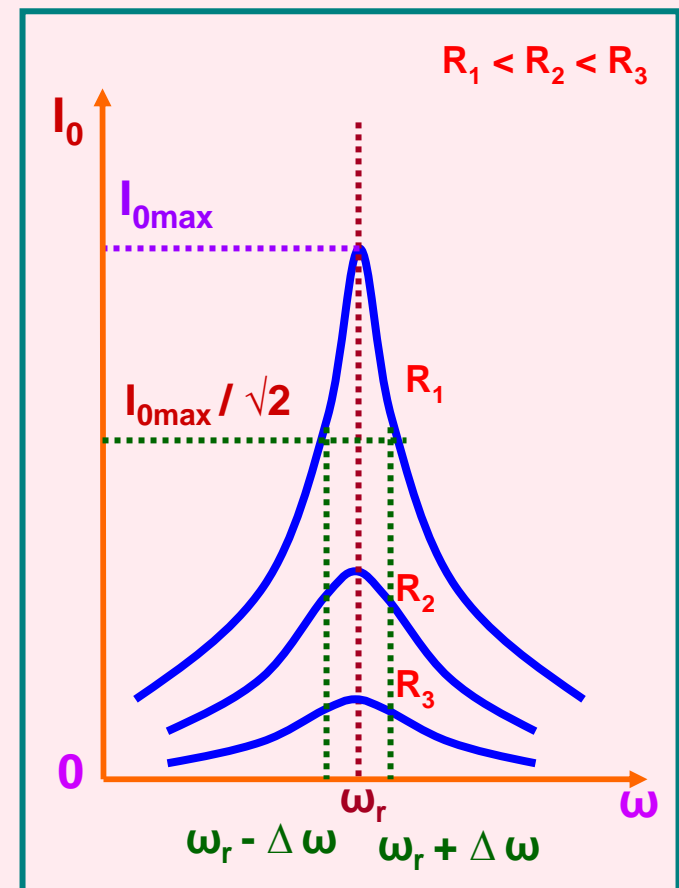

Power in AC Circuit with L, C, R:

$$E = E_0 \sin \omega t$$

$$I = I_0 \sin (\omega t + \Phi) \quad (\text{where } \Phi \text{ is the phase angle between emf and current})$$

$$\text{Instantaneous Power} = E I$$

$$= E_0 I_0 \sin \omega t \sin (\omega t + \Phi)$$

$$= E_0 I_0 [\sin^2 \omega t \cos \Phi + \sin \omega t \cos \omega t \cos \Phi]$$

If the instantaneous power is assumed to be constant for an infinitesimally small time dt , then the work done is

$$dW = E_0 I_0 [\sin^2 \omega t \cos \Phi + \sin \omega t \cos \omega t \cos \Phi]$$

Work done over a complete cycle is

$$W = \int_0^T E_0 I_0 [\sin^2 \omega t \cos \Phi + \sin \omega t \cos \omega t \cos \Phi] dt$$

$$W = E_0 I_0 \cos \Phi \times T / 2$$

Average Power over a cycle is $P_{av} = W / T$

$$P_{av} = (E_0 I_0 / 2) \cos \Phi$$

(where $\cos \Phi = R / Z$)

$$P_{av} = (E_0 / \sqrt{2}) (I_0 / \sqrt{2}) \cos \Phi$$

$$= R / \sqrt{[R^2 + (\omega L - 1/\omega C)^2]}$$

is called Power Factor)

$$P_{av} = E_v I_v \cos \Phi$$

$$P_{av} = E_v I_v \cos \Phi$$

Power in AC Circuit with R:

In R, current and emf are in phase.

$$\Phi = 0^\circ$$

$$P_{av} = E_v I_v \cos \Phi = E_v I_v \cos 0^\circ = E_v I_v$$

Power in AC Circuit with L:

In L, current lags behind emf by $\pi/2$.

$$\Phi = -\pi/2$$

$$P_{av} = E_v I_v \cos (-\pi/2) = E_v I_v (0) = 0$$

Power in AC Circuit with C:

In C, current leads emf by $\pi/2$.

$$\Phi = +\pi/2$$

$$P_{av} = E_v I_v \cos (\pi/2) = E_v I_v (0) = 0$$

Note:

Power (Energy) is not dissipated in Inductor and Capacitor and hence they find a lot of practical applications and in devices using alternating current.

Wattless Current or Idle Current:

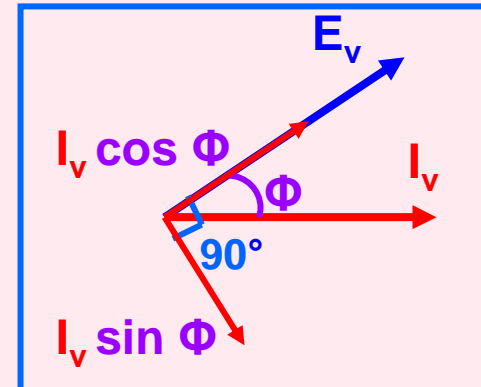

The component $I_v \cos \Phi$ generates power with E_v .

However, the component $I_v \sin \Phi$ does not contribute to power along E_v and hence power generated is zero. This component of current is called wattless or idle current.

$$P = E_v I_v \sin \Phi \cos 90^\circ = 0$$

L C Oscillations:

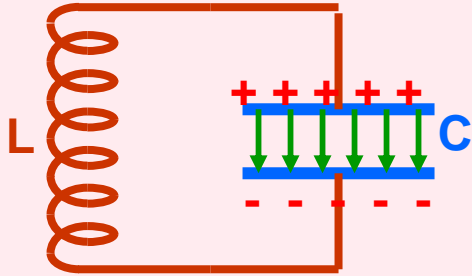

At $t = 0$, $U_E = \text{Max.}$ & $U_B = 0$

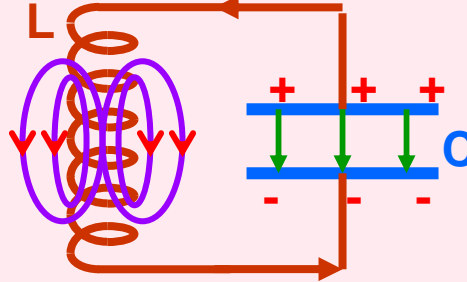

At $t = T/8$, $U_E = U_B$

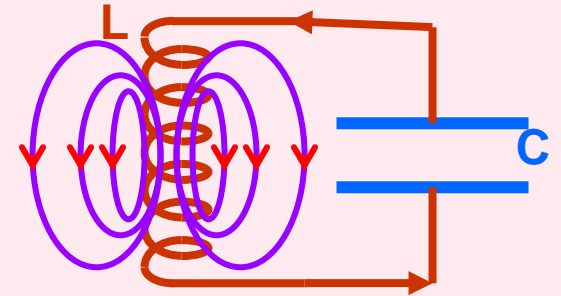

At $t = 2T/8$, $U_E = 0$ & $U_B = \text{Max.}$

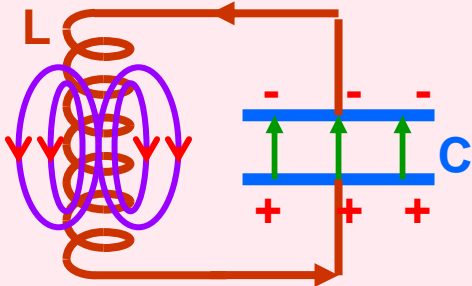

At $t = 3T/8$, $U_E = U_B$

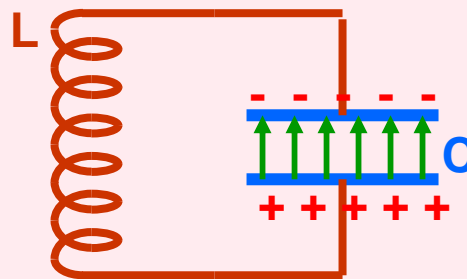

At $t = 4T/8$, $U_E = \text{Max.}$ & $U_B = 0$

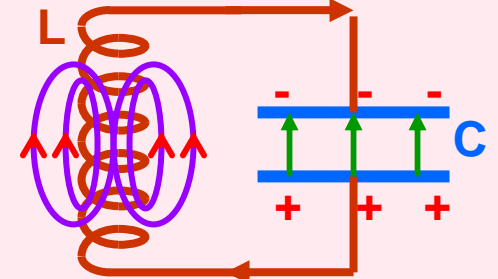

At $t = 5T/8$, $U_E = U_B$

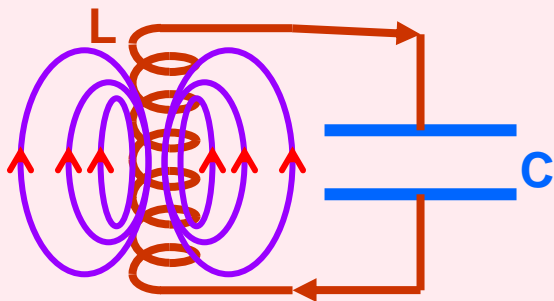

At $t = 6T/8$, $U_E = 0$ & $U_B = \text{Max.}$

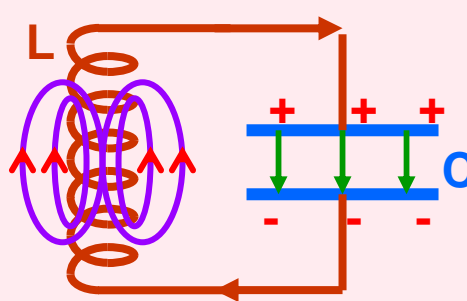

At $t = 7T/8$, $U_E = U_B$

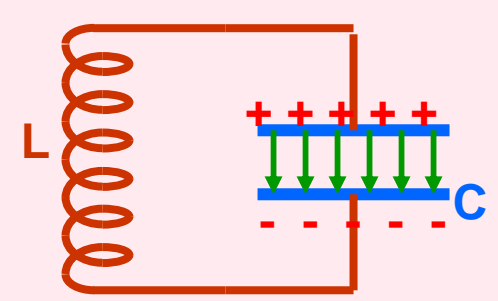

At $t = T$, $U_E = \text{Max.}$ & $U_B = 0$

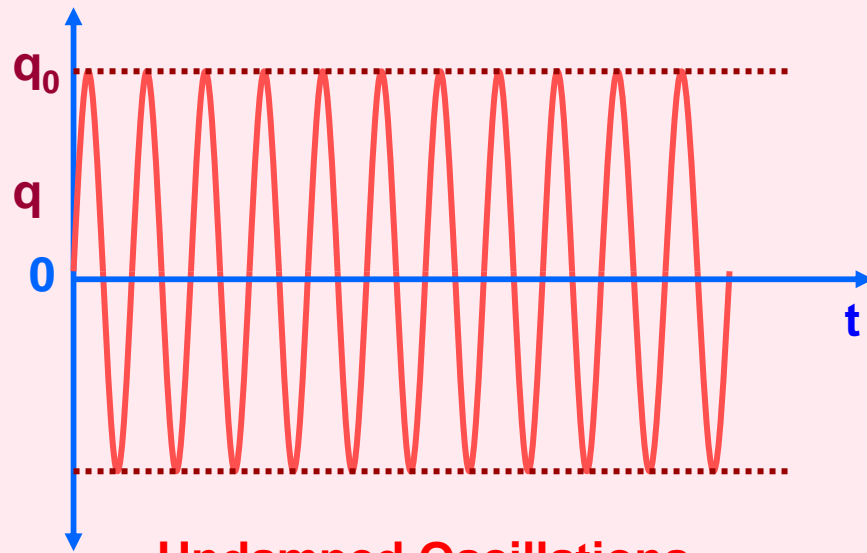

Undamped Oscillations

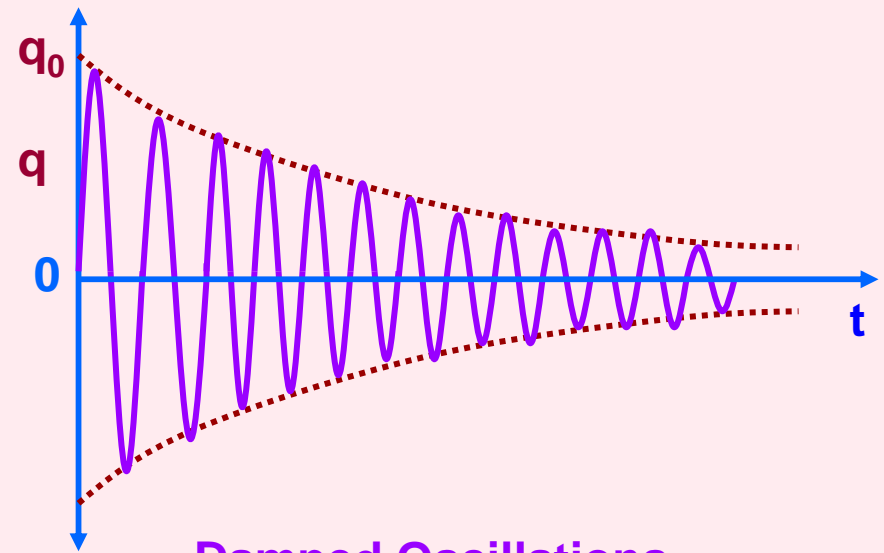

Damped Oscillations

If q be the charge on the capacitor at any time t and di / dt the rate of change of current, then

$$L \frac{di}{dt} + \frac{q}{C} = 0$$

$$\text{or } L \left(\frac{d^2q}{dt^2} \right) + \frac{q}{C} = 0$$

$$\text{or } \frac{d^2q}{dt^2} + \frac{q}{LC} = 0$$

$$\text{Putting } \frac{1}{LC} = \omega^2$$

$$\frac{d^2q}{dt^2} + \omega^2 q = 0$$

The final equation represents **Simple Harmonic Electrical Oscillation** with ω as angular frequency.

$$\text{So, } \omega = \frac{1}{\sqrt{LC}}$$

$$\text{or } f = \frac{1}{2\pi \sqrt{LC}}$$

Transformer:

Transformer is a device which converts lower alternating voltage at higher current into higher alternating voltage at lower current.

Principle:

Transformer is based on Mutual Induction.

It is the phenomenon of inducing emf in the secondary coil due to change in current in the primary coil and hence the change in magnetic flux in the secondary coil.

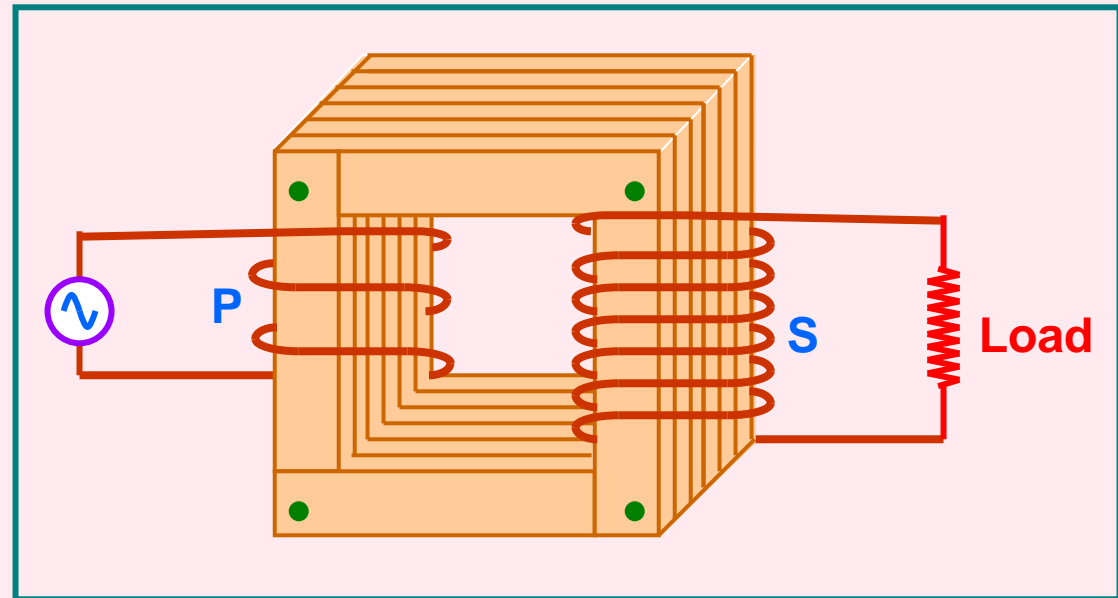

Theory:

$$E_p = - N_p d\Phi / dt$$

$$E_s = - N_s d\Phi / dt$$

$$E_s / E_p = N_s / N_p = K$$

(where K is called Transformation Ratio or Turns Ratio)

For an ideal transformer,

Output Power = Input Power

$$E_s I_s = E_p I_p$$

$$E_s / E_p = I_p / I_s$$

$$E_s / E_p = I_p / I_s = N_s / N_p$$

Efficiency (η):

$$\eta = E_s I_s / E_p I_p$$

For an ideal transformer η is 100%

Step - up Transformer:

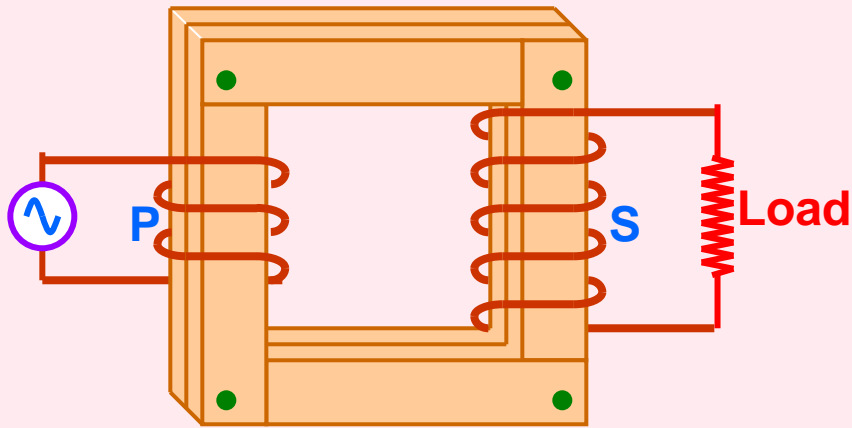

$$N_s > N_p \text{ i.e. } K > 1$$

$$E_s > E_p \text{ \& } I_s < I_p$$

Step - down Transformer:

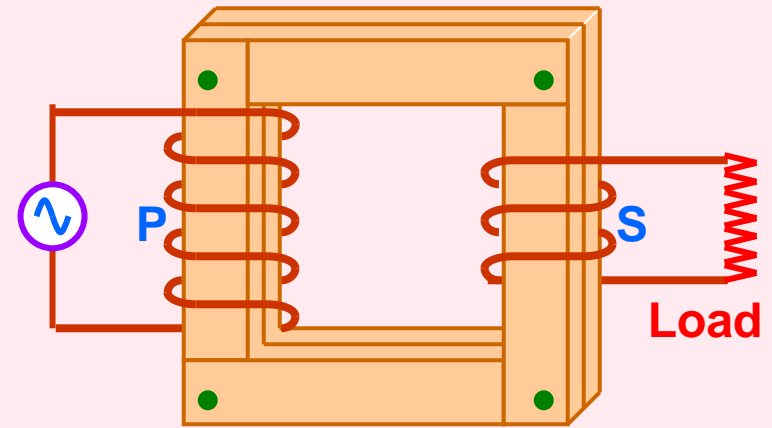

$$N_s < N_p \text{ i.e. } K < 1$$

$$E_s < E_p \text{ \& } I_s > I_p$$

Energy Losses in a Transformer:

1. **Copper Loss:** Heat is produced due to the resistance of the copper windings of Primary and Secondary coils when current flows through them.

This can be avoided by using thick wires for winding.

2. **Flux Loss:** In actual transformer coupling between Primary and Secondary coil is not perfect. So, a certain amount of magnetic flux is wasted.

Linking can be maximised by winding the coils over one another.

3. Iron Losses:

a) Eddy Currents Losses:

When a changing magnetic flux is linked with the iron core, eddy currents are set up which in turn produce heat and energy is wasted.

Eddy currents are reduced by using laminated core instead of a solid iron block because in laminated core the eddy currents are confined within the lamination and they do not get added up to produce larger current. In other words their paths are broken instead of continuous ones.

b) Hysteresis Loss:

When alternating current is passed, the iron core is magnetised and demagnetised repeatedly over the cycles and some energy is being lost in the process.

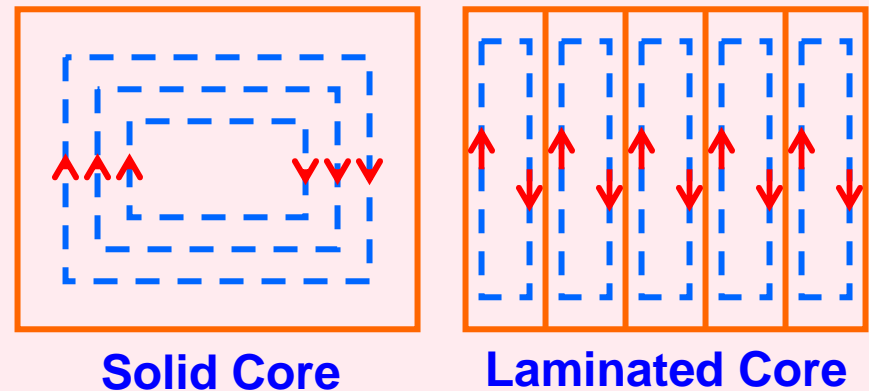

This can be minimised by using suitable material with thin hysteresis loop.

4. **Losses due to vibration of core:** Some electrical energy is lost in the form of mechanical energy due to vibration of the core and humming noise due to magnetostriction effect.

A.C. Generator:

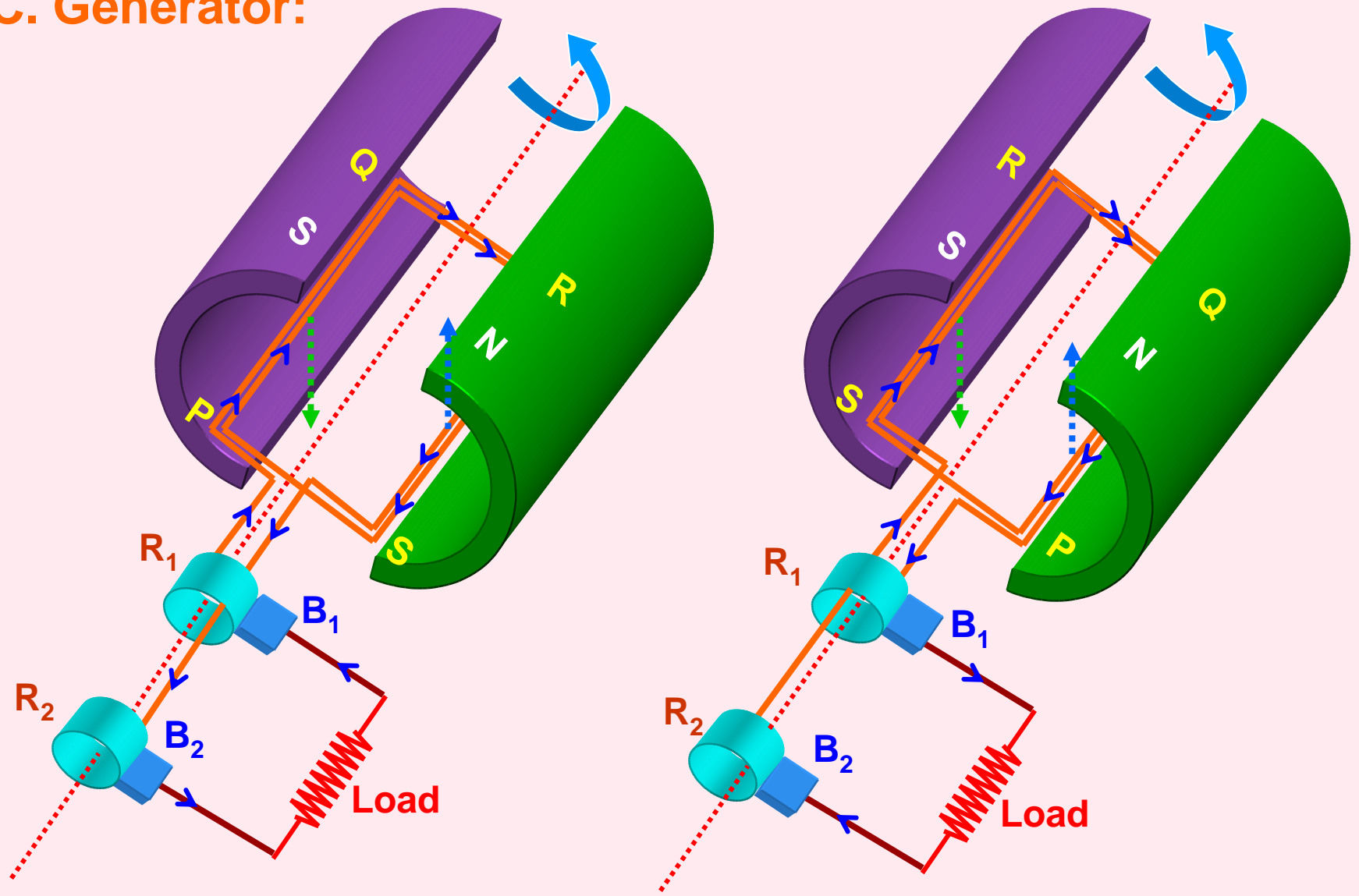

A.C. Generator or A.C. Dynamo or Alternator is a device which converts mechanical energy into alternating current (electrical energy).

Principle:

A.C. Generator is based on the principle of Electromagnetic Induction.

Construction:

- (i) Field Magnet with poles N and S
- (ii) Armature (Coil) PQRS
- (iii) Slip Rings (R_1 and R_2)
- (iv) Brushes (B_1 and B_2)
- (v) Load

Working:

Let the armature be rotated in such a way that the arm PQ goes down and RS comes up from the plane of the diagram. Induced emf and hence current is set up in the coil. By Fleming's Right Hand Rule, the direction of the current is $PQRSR_2B_2B_1R_1P$.

After half the rotation of the coil, the arm PQ comes up and RS goes down into the plane of the diagram. By Fleming's Right Hand Rule, the direction of the current is $PR_1B_1B_2R_2SRQP$.

If one way of current is taken +ve, then the reverse current is taken -ve.

Therefore the current is said to be alternating and the corresponding wave is sinusoidal.

Theory:

$$\Phi = N B A \cos \theta$$

At time t , with angular velocity ω ,

$\theta = \omega t$ (at $t = 0$, loop is assumed to be perpendicular to the magnetic field and $\theta = 0^\circ$)

$$\therefore \Phi = N B A \cos \omega t$$

Differentiating w.r.t. t ,

$$d\Phi / dt = - N B A \omega \sin \omega t$$

$$E = - d\Phi / dt$$

$$E = N B A \omega \sin \omega t$$

$$E = E_0 \sin \omega t \quad (\text{where } E_0 = N B A \omega)$$

